



**Oval wheel meter  
with Universal Smart Transmitter  
with HART® Communication**

**OaP-Series  
UST**

Ex d – version

Ex d (terminal compartment, flameproof) / Ex i (electronic compartment, intrinsically safe) – version

**USTD**

**USTX**

**Operating Manual**



# Table of Contents

Foreword.....	4
I. Transport, Delivery, Storage.....	4
II. Warranty .....	4
III. General safety instructions .....	4
IV Basic Safety Information .....	4
V. CMOS - Components .....	5
VI Intended Use .....	5
1. Identification.....	6
2. Range of Application.....	6
3. Working Principle and System Design .....	6
3.1 MEASURING PRINCIPLE.....	6
3.2 SYSTEM DESIGN .....	7
4. Input.....	7
4.1 MEASURED VALUE .....	7
4.2 MEASURING RANGE.....	8
5. Output .....	9
5.1 OUTPUT SIGNAL .....	9
5.1.1 Analog current output .....	9
5.1.2 Pulse output .....	9
5.1.2.1 2 - wire current pulse output .....	9
5.1.2.2 Pulse output according to NAMUR– not for Version USTX.....	10
5.2 LOAD .....	10
5.3 ELECTRICAL AND THERMAL SAFETY DATA .....	11
5.3.1 USTD → Ex d UST flameproof enclosure .....	11
5.3.2 USTX → Ex d (terminal compartment) / Ex i (electronic compartment, intrinsically safe) .....	12
6. Characteristic Parameter .....	13
6.1 REFERENCE CONDITIONS .....	13
6.2 MEASUREMENT DEVIATION .....	13
6.3 REPEATABILITY.....	13
6.4 SETTLING TIME .....	13
6.5 SWITCH-ON DRIFT.....	13
6.6 LONG-TERM DRIFT .....	13
7. Operating conditions .....	13
7.1 INSTALLATION CONDITIONS.....	13
7.1.1 Installation instructions .....	13
7.1.1.1 General Information .....	13
7.1.1.2 Installation.....	14
7.1.2 Start-up Instructions .....	14
7.2. ENVIRONMENTAL CONDITIONS .....	14
7.2.1 Ambient temperature .....	14
7.2.2 Ambient temperature range.....	15
7.2.3 Storing temperature.....	15
7.2.4 Climatic category.....	15
7.2.5 Degree of protection .....	15
7.2.6 Electromagnetic compatibility.....	15
7.3. PROCESS CONDITIONS .....	15
7.3.1 Medium Temperature .....	15
7.3.2 State of aggregation .....	15
7.3.3 Viscosity .....	15
7.3.4 Medium temperature range .....	16
7.3.5 Medium pressure range .....	16

7.3.6 Pressure loss.....	17
8. Construction details .....	18
8.1 DESIGN/DIMENSIONS.....	18
8.2 WEIGHT .....	19
8.3 MATERIAL .....	19
8.4 PROCESS CONNECTION .....	20
8.5 ELECTRICAL CONNECTION .....	20
8.5.1 Operation with PACTware Software .....	21
9. Display and user interface .....	21
9.1 GENERAL .....	21
9.2 LC - DISPLAY .....	21
9.3. OPERATION WITH HART®-COMMUNICATION .....	22
9.3.1 PACTware .....	22
9.3.2 HART®-communicator .....	22
9.4 DEVICE FUNCTIONS AND PARAMETER.....	23
9.4.1 MEASURING VALUES .....	23
9.4.2 Output.....	23
9.4.3 Device Parameter.....	23
9.4.4 Dialog / Functions.....	24
9.4.5 HART® .....	25
9.5 CHECKING THE MAXIMUM OUTPUT FREQUENCY OF THE PULSE OUTPUT .....	25
10. Connection of the Universal Smart Transmitter UST .....	26
11. 10-points linearization.....	27
Appendix.....	28
A. Trouble shooting and debugging.....	28
A.1 FAULT IN THE ELECTRONIC TRANSMITTER .....	28
B Maintenance, cleaning and changing the Display.....	31
B.1 MAINTENANCE, CLEANING .....	31
B.2 REPAIR / HAZARDOUS MATERIAL.....	31
B.3 ROTATING THE DISPLAY .....	31
B.4 ROTATING THE HOUSING.....	32
C. Application examples .....	32
C.1 APPLICATION EXAMPLE 1: USTD / USTX.....	32
C.2 APPLICATION EXAMPLE 2: USTD / USTX.....	33
C.3 APPLICATION EXAMPLE 3: USTD .....	33
D. Declaration on Decontamination.....	34
E. Certificates .....	35
E.1 EXPLOSIONS PROTECTION CERTIFICATES .....	35
E.1.1 USTD: EC TYPE EXAMINATION EX-APPROVAL DMT 00 ATEX E 025 X.....	35
E.1.2 USTX: EC Type Examination Ex-Approval BVS 04 ATEX E 022X .....	35
E.2 PRESSURE EQUIPMENT DIRECTIVE: .....	35
E.2.1 Conformity to Type: .....	35
E.2.2 EU TYPE EXAMINATION CERTIFICATE.....	36
E.3 EU – DECLARATION OF CONFORMITY .....	37

## Foreword

### I. Transport, Delivery, Storage

Always protect devices against moisture, humidity, contamination, impacts and damages.

#### Check of the delivery:

The shipment is to be checked for completeness upon receipt. The data of the device are to be compared with the data of the delivery note and the order documents. Any transport damage must be reported immediately after delivery. Damage reported later cannot be accepted.

### II. Warranty

The scope and period of a warranty can be found in the contractual delivery conditions.

A warranty claim presupposes professional assembly and commissioning in accordance with the operating instructions valid for the device. The necessary assembly, commissioning and maintenance work may only be carried out by competent and authorized persons.

### III. General safety instructions

1. Oval wheel meters are reliable, high-precision volumetric instruments and may only be used in accordance with their intended purpose. The pressure and temperature limits of use indicated on the nameplate as well as the other technical data of the devices and safety instructions must be observed during installation, commissioning and operation of the devices.
2. National and international regulations for the operation of pressurized devices and systems must be observed.
3. Before installation, the operator must ensure that the pressurized parts have not been damaged during transport.
4. Always observe national and international regulations concerning the operation of devices in potentially explosive atmospheres.
5. The equipment must be installed, operated and maintained by qualified personnel. The operator is responsible for ensuring that the personnel are adequately and appropriately qualified. In the case of doubts, the manufacturer must be consulted.
6. The operator must ensure that the materials used (wetted parts) of the device are chemically resistant to the measuring medium.
7. The seals or sealing elements must be handled with care in accordance with the specifications in the operating instructions.
8. The tightening torques for the screw connections between the cover and the lower part of the housing as well as for the flange connections in the pipeline, are available on request.
9. The drain screws and all screw connections of the pressure-bearing parts must not be loosened until it has been ensured that the meter is depressurized.

### IV Basic Safety Information

Description of Symbols:

	<p><b>IMPORTANT NOTES!</b></p> <p>Please consider these notes carefully to achieve a reliable functional system. The accompanying text contains important information about the product, handling the product or about a section of the document that is of particular importance.</p>
---	--

	<p><b>WARNING!</b></p> <p>Failure to take the prescribed precautions could result in death, severe bodily injury, or substantial material / product damage.</p>
---	---

## V. CMOS - Components

The electronic transmitter uses CMOS chips. Therefore, when the electronics housing is opened, static electricity discharges must be avoided. These can damage the electronic transmitter. Bopp & Reuther Messtechnik GmbH may not be held liable for any damages, which are caused either indirectly or directly by improper handling.

Use only antistatic transport containers for transport of electronic assembly groups.

## VI Intended Use

Oval wheel meters series OaP are used for measuring liquid raw, intermediate and finished products such as liquefied gases, gasolines, heating oils, lubricating oils, transmission oils, solvents, bitumen, alkaline solutions, acids and other chemical liquids.

### Intended User

The intended user is not a general purpose user.



The intended user is not allowed to open, manipulate or dismantle the device.  
The device may be maintained, serviced or opened only by dedicated and qualified service personnel.

## 1. Identification

Manufacturer:	Bopp & Reuther Messtechnik GmbH Am Neuen Rheinhafen 4 67346 Speyer, Germany Phone: +49 6232 657-0 Fax: +49 6232 657-505
Product type:	Direct volumetric meters (positive displacement flowmeters)
Product name:	Oval wheel meter series OaP with Universal Smart Transmitter (UST) and HART® - Protocol <b>USTD:</b> Ex d - version <b>USTX:</b> Ex d (terminal compartment, flameproof) / Ex i (electronic compartment, intrinsically safe) – version
Version no.:	A-EN-01224-XD Rev.D

## 2. Range of Application

Volume control of liquid products in the petroleum, chemical and petrochemical industries requires volumetric meters whose design and materials of construction are adapted to the special operating conditions of the pumped media.

The field of application for all oval wheel meters of the series OaP lies in the measurement, dosing, regulation and control of liquid quantities, filling tank trucks, tank wagons and ships, as well as in pipeline operation. The measurement of liquids of very high viscosity with low pressure loss should be particularly emphasised here.

## 3. Working Principle and System Design

### 3.1 Measuring Principle

Oval wheel meter belongs to the group of direct volumetric meters for liquids with movable partition walls (positive displacement flow meters). The oval wheel meter consists of measuring chamber housing with two pivoted oval wheels which are toothed and roll off each other in counter-rotations. The diagram displays oval wheel movement during the measurement process.

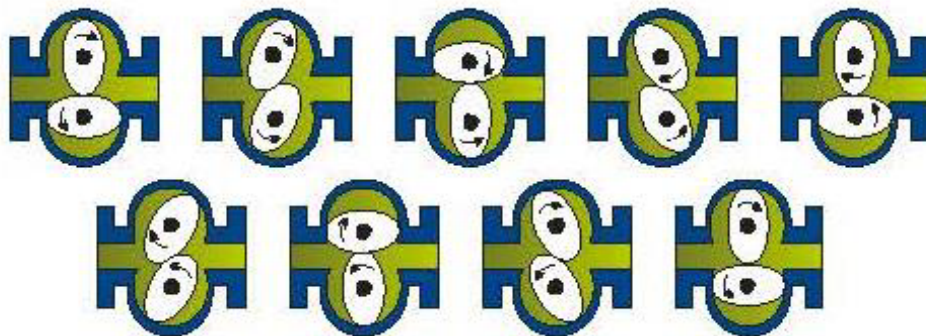

In each revolution, the oval wheels displace a discrete volume of liquid (that is defined by the space between the oval wheel and measuring chamber) through the chamber.

For measuring purposes the rotation of the oval wheel is transmitted from the pressure chamber to the outside via an electromagnetic sensor according to the Wiegand principle and is processed to a standardized electrical signal or counter display.

### 3.2 System design

The oval wheel meter with Universal Smart Transmitter (USTI) consists of the following components:

**Transducer:**

Measuring of the volumetric flow and the volume is performed by the oval wheel meter.

**Pulse pick-up:**

Pulse generators according to the Wiegand principle of the AG44 series are used for signal acquisition.



**Transmitter (USTI):**



The USTI electronic transmitter pre-processes and evaluates the meter pulses.

An analog 2-wire technology based 4 - 20 mA current loop, a digital communication module with HART® protocol as well as a separate pulse output for the measuring of the volume (original pulses or scaled pulses) according to NAMUR are the standard features of the device.

## 4. Input

### 4.1 Measured value

Volume and volumetric flow

## 4.2 Measuring Range

Type	DN	Flowrate $Q_{max}$ [l/min]	Ranges at viscosity	< 0.3 mPa·s		0.3 – 1.5 mPa·s		1.5 - 150 mPa·s		to 350 mPa·s		to 1000 mPa·s		to 3000 mPa·s	
				[l/min]	[m³/h]	[l/min]	[m³/h]	[l/min]	[m³/h]	[l/min]	[m³/h]	[l/min]	[m³/h]	[l/min]	[m³/h]
OAP5	25	60 (3.6m³/h)	Min	8	0.5	5	0.3	5	0.3	2.5	0.15	1.25	0.075	0.45	0.027
			Max	48	3.0	60	3.6	60	3.6	30	1.8	15	0.9	5.4	0.32
			Continuous	18	1.1	36	2.2	50	3	28	1.7	14	0.83	5	0.3
OAP10	25	120 (7.2 m³/h)	Min	16	1.0	10	0.6	10	0.6	7	0.42	3.5	0.20	1.2	0.072
			Max	96	6.0	120	7.2	120	7.2	84	5	42	2.4	14.4	0.86
			Continuous	36	2.2	73	4.4	99	5.9	77	4.6	39	2.2	13.2	0.79
OAP50	50	360 (21.6 m³/h)	Min	50	3.0	30	1.8	30	1.8	18	1.08	9.0	0.54	3	0.18
			Max	300	18	360	21.6	360	21.6	216	13	108	6.5	36	2.2
			Continuous	110	6.6	220	13	297	18	198	12	99	5.9	33	2
OAP125	65	840 (50.4 m³/h)	Min	100	6	70	4.2	70	4.2	60	3.6	40	2.4	15	0.9
			Max	600	36	840	50.4	840	50.4	720	43	480	29	180	11
			Continuous	220	13	460	28	578	35	660	40	440	26	165	10
OAP250	80	1440 (86.4 m³/h)	Min	200	12	120	7.2	120	7.2	100	6	60	3.6	30	1.8
			Max	1200	72	1440	86.4	1440	86.4	1200	72	720	43	360	22
			Continuous	440	26	790	48	1100	66	1100	66	660	40	330	20
OAP600	100	3600 (216 m³/h)	Min	400	24	250	15	250	15	200	12	150	9	75	4.5
			Max	2400	140	3600	216	3600	216	3000	180	1800	110	900	54
			Continuous	880	53	1800	110	2750	165	2750	165	1650	100	830	50
OAP1200	150 6"	6000 (360 m³/h)	Min	800	48	500	30	500	30	400	24	250	15	120	7.2
			Max	4800	290	6000	360	6000	360	4800	290	3000	180	1400	86
			Continuous	1800	110	2800	170	3900	220	4400	260	2800	170	1300	79
OAP2000	200 8"	9600 (576 m³/h)	Min	1300	80	800	48	800	48	660	40	400	24	200	12
			Max	7800	480	9600	576	9600	576	7900	480	4800	290	2400	140
			Continuous	2900	180	4400	260	6100	350	7300	440	4400	260	2200	130
OAP3200	300 12"	14400 (864 m³/h)	Min	2000	120	1200	72	1200	72	1000	60	600	36	300	18
			Max	12000	720	14400	864	14400	864	12000	720	7200	430	3600	220
			Continuous	4400	260	6600	400	8800	530	11000	660	6600	400	3300	200
OAP4000	400 16"	24000 (1.440 m³/h)	Min	3200	200	2000	120	2000	120	1500	90	1000	60	400	42
			Max	19000	1200	24000	1440	24000	1440	18000	1100	12000	720	4800	290
			Continuous	7300	440	11000	660	15000	880	17000	1000	11000	660	4400	260

Measuring ranges for cold water: column 0.3 - 1.5 mPa·s (for continuous operation apply 50% and for max. flow rate resp. batching 70% of the line 2 (max))

Measuring ranges for hot water: column < 0.3 mPa·s line min. to continuous.

> 150 mPa·s special toothed oval wheels are special toothed for cast wheels from OaP 10



## 5. Output

### 5.1 Output Signal

The output signals are available as analog output or as current pulse output with two-wire technology, as well as separate NAMUR pulse output.

Version **USTX** has no NAMUR-pulses.

#### 5.1.1 Analog current output

The flow is a unit signal output of 4-20 mA. Lower range value (LRV), Upper range value (URV) and damping can be pre-set. The analog current output transmits the analog flow measurement value within the range of 4-20 mA.

#### 5.1.2 Pulse output

Two different types of pulse outputs (current pulse or NAMUR pulse) are available for the transmission of volume flow. Output can either be set as original pulse without evaluation or as scaled pulse with selectable pulse width. This applies to both types of pulse outputs. The pulse value can be scaled with an additional factor with respect to the internal meter increments. The original pulse has a set pulse width of 0.5ms. The maximum output frequency is 1 kHz. The pulse width for the scalable pulse can be selected, thus putting a limit to the maximum output frequency.

#### Overall View of the display

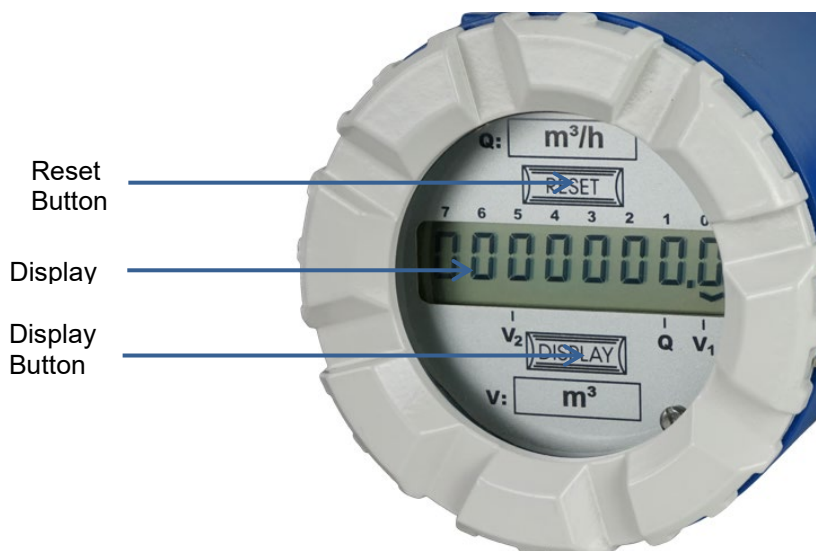

#### 5.1.2.1 2 - wire current pulse output

On the 2-wire current loop, the output signal is a current pulse between 4 mA = low and 20 mA = high. This pulse output can be activated by means of a double switch / slide switch on the power supply circuit board. The current pulse is provided at terminal 1 and 2 of the current loop. (The analog signal of 4-20 mA for the volume flow is no longer available). HART®-communication is only possible to a limited extent.



It is important to check that the device is not supplied with any source of power before opening the glass cover.

For better visibility of this function, the top glass cover has been removed in the below image.

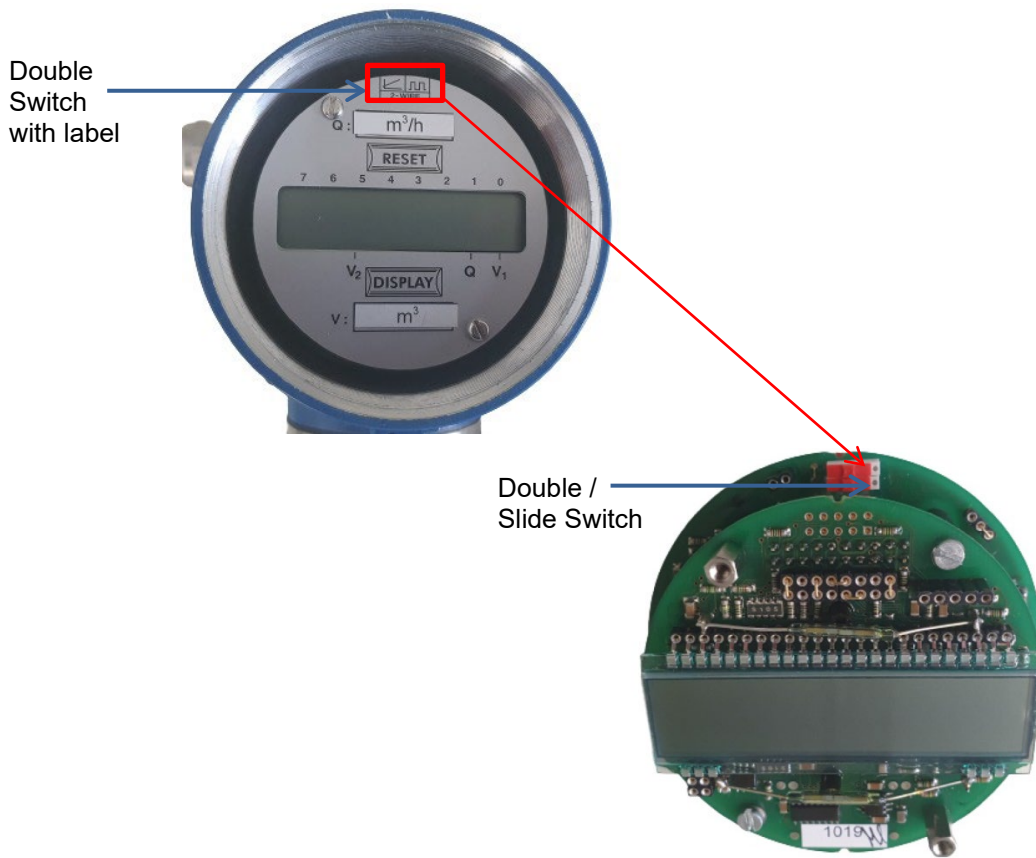

### 5.1.2.2 Pulse output according to NAMUR– not for Version USTX

The NAMUR-pulse output is provided at the terminals 3 and 4. The signals are designed according to the European standard EN 60947-5-6.

## 5.2 Load

Several parameters must be considered for the allowable load.

In order to insure secure HART® communications, the limits for the minimal load with  $R_L \geq 230 \Omega$  and the maximum load with  $R_L \leq 1100 \Omega$  must be observed.

### Maximum load:

The maximum load depends on the supply voltage:

#### Applies to USTD:

For  $U_B < 15.2 \text{ V}$ :

$$R = (U_B - 14 \text{ V}) / 0.004 \text{ A}$$

For  $U_B \geq 15.2 \text{ V}$ :

$$R = (U_B - 8.5 \text{ V}) / 0.022 \text{ A}$$

#### Applies to USTX:

For  $U_B < 17.2 \text{ V}$ :

$$R = (U_B - 16 \text{ V}) / 0.004 \text{ A}$$

For  $U_B \geq 17.2 \text{ V}$ :

$$R = (U_B - 10.5 \text{ V}) / 0.022 \text{ A}$$

The resistance values are given in Ω.

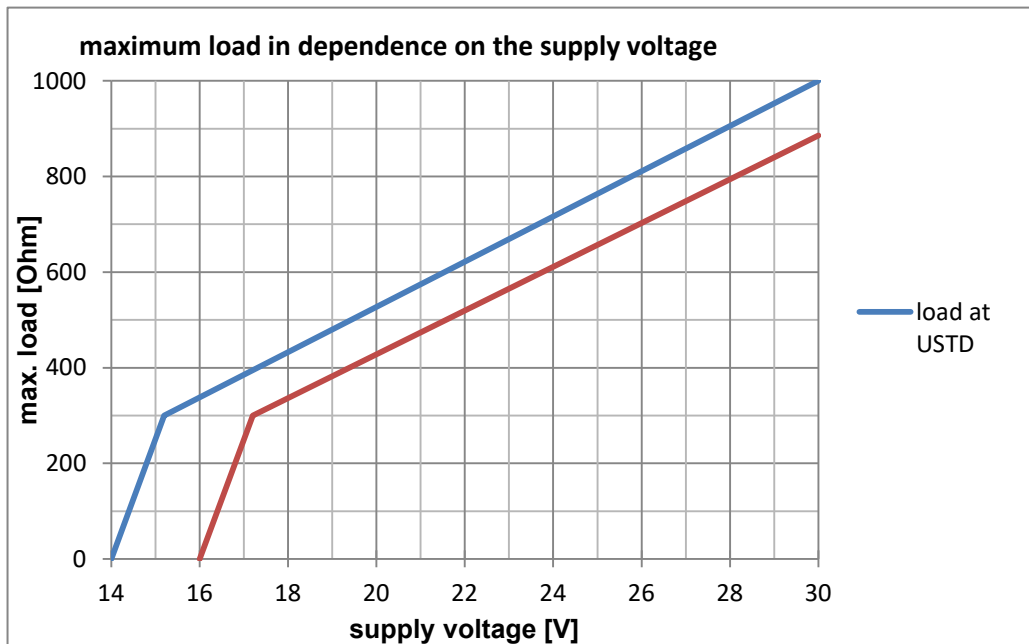

### 5.3 Electrical and thermal safety data

#### 5.3.1 USTD → Ex d UST flameproof enclosure

1. Power supply and signal circuits (terminals 1 and 2)

Reference Voltage	$U_N$	=	DC 24 V
	$U_M$	=	AC 250 V
Reference Amperage	$I_N$	=	4-20 mA
Nominal Output	$P_N$	=	600 mW

2. NAMUR opto-coupler output (terminals 3 and 4)

Reference voltage	$U_N$	=	DC 8 V
	$U_M$	=	AC 250 V

3. Sensor circuit with protection type Ex ia IIC (to be connected to pulse emitting sensors).

Voltage	$U_o$	=	UC 9.25 V
Amperage	$I_o$	=	5.2 mA
Output	$P_o$	=	12 mW
Internal inductivity	$L_i$	=	negligible
Characteristic line		=	linear

	IIC	IIB
Max. concentrated capacity $C_i + C_o$ and concentrated inductivity $L_o$ (mixed connection)	200 nF 846 mH	200 nF 2.325 H
Relation inductivity-resistance $L_i/R_i$	-	11.82 mH/Ω

4. The ambient temperature for the Universal Smart Transmitter is:  
Type **\*\*\*USTD\*\*\***:  $-40^\circ\text{C} \leq T_a \leq +70^\circ\text{C}$  (Ex d - version)

#### Special conditions for safe use

For versions of the Universal Smart Transmitter for direct mounting on the sensor, the influence of external heat sources (process temperature) on the housing temperature must be taken into account.

An optional thermal insulation may extend to half of the extension. The ambient temperature must be maintained directly around the electronics housing.

Class	T <sub>U</sub>	T <sub>Media</sub>
T3	64	170
T4	66	135
T4	67	110
T4	70	70
minimum	-20	-10
		optional -60

for all classes

### 5.3.2 USTX -> Ex d (terminal compartment) / Ex i (electronic compartment, intrinsically safe)

(Note: In approval USTI, because electronic intrinsically safe)

1. Non-intrinsically safe supply and signal circuit (clamps 1 and 2) (4-20 mA current loop)

Rated voltage	U <sub>N</sub>	=	DC 24 V
max. permitted voltage for normal operation			DC 26 V
	U <sub>m</sub>	=	AC 250 V
Power consumption	P <sub>N</sub>	=	1 W

#### Special conditions for safe use

The "-" pole of the non-intrinsically safe supply and signal circuit is connected to the housing. The earthing of the non-intrinsically safe supply and signal circuit / housing must comply with section 6.6 of EN 50020:2002.

2. Internal intrinsically safe supply and signal circuit  
(Internal safety shunt assembly providing current limitation, level of protection Ex ib IIC)

Voltage	U <sub>o</sub>	=	DC 30 V
Short circuit current	I <sub>o</sub>	=	26.6 mA
Power	P <sub>o</sub>	=	798 mW

3. Pick-up circuits (types of protection Ex ib IIC ) for connection passive pick-ups; Galvanically connected with the supply and signal circuit

Sensors	AG44	Contact
Connection Terminals	7 and 8	5 and 6
Voltage U <sub>o</sub>	1 V	6.6 V
Amperage I <sub>o</sub>	4 mA	23 mA
Output P <sub>o</sub>	1 mW	37 mW
max. external capacitance C <sub>o</sub>	≤ 100 μF	≤ 22 μF
max. external inductance L <sub>o</sub>	≤ 1 H	≤ 35 mH
max. external capacitance C <sub>o</sub> (mixed switching –on)	≤ 4 μF	≤ 0.9 μF
max. external inductance L <sub>o</sub> (mixed switching –on)	≤ 1 H	≤ 1.5 mH
Inductance-resistance ratio L <sub>o</sub> /R <sub>o</sub>	40.5 mH/Ω	0.93 mH/Ω

4. The ambient temperature for the Universal Smart Transmitter is:  
Type **\*\*\*USTX\*\*\***: -40°C ≤ T<sub>a</sub> ≤ +60°C

An optional thermal insulation may extend to half of the extension. The ambient temperature must be maintained directly around the electronics housing.

Class	T <sub>U</sub>	T <sub>Media</sub>
T3	64	170
T4	66	135
T4	67	110
T4	70	70
minimum	-20	-10
		optional -60

for all classes

## 6. Characteristic Parameter

### 6.1 Reference conditions

All oval wheel meters are calibrated on test benches approved for fiscal metering.

Pressure: 2 to 7 bar

Temperature: 20°C to 30°C

### 6.2 Measurement deviation

Lin.  $\pm 0.05\%$  to  $\pm 0.3\%$  of the measured value (depending on product characteristics and measuring range)

### 6.3 Repeatability

< 0.02%

### 6.4 Settling time

1 s

### 6.5 Switch-on drift

2 s

### 6.6 Long-term drift

< 0.005 % / year

## 7. Operating conditions

### 7.1 Installation conditions

#### 7.1.1 Installation instructions



The operating instructions must be read and observed before assembly and commissioning.  
The system must be **depressurized** and **cooled down** before assembly and disassembly of the device.

##### 7.1.1.1 General Information

- Only trained specialist personnel authorised by the system operator may carry out assembly, electrical installations, commissioning, maintenance work and operation. They must have read and understood the operating manual and follow its instructions without fail.
- Bopp & Reuther Messtechnik oval wheel meters are precision volumetric flowmeters. Inlet and outlet connections are covered with protective caps against foreign substances. Please remove the protective caps only prior to use.

- Observe the operating data marked on the oval wheel, the order confirmation and the configuration data sheet. If you want to use the device under differing operating conditions, consult Bopp & Reuther Messtechnik GmbH indicating the serial number.
- Install the oval wheel meter in the pressure pipe behind the pump
- Install the oval wheel meter in such a way, that it remains filled with liquid also in non-operating condition.
- To avoid measuring errors due to air bubbles or contamination, preventive measures must be taken (e.g. gas separator or strainer).
- Oval wheel meters intended for liquid food products must be cleaned thoroughly before putting them into operation (see Maintenance and Cleaning).

### 7.1.1.2 Installation

- Flush and purge the pipe. When doing so, replace the oval wheel meter with an adapter piece.
- Do not remove the caps on the in- and outlet of the oval wheel meter until the device is being installed to prevent ingress of foreign substances.
- The flow direction is indicated by an arrow on the housing of the oval wheel meter.
- The housing cover of the oval wheel meter is to be placed vertically so that the axes of the oval Wheel are in a horizontal position independent of the position of the pipe.
- The oval wheel meter must be installed free from strain.

#### USTD:

The **USTD** can be used together with the pulse pick-up series AG4x (41, 42, 43) according to the protection type „flameproof“  $\text{Ex}$  II 2G Ex [ia] IIC / IIB T6 in the Ex-area.

#### USTX:

The **USTX** can be installed together with the pulse pulse pick-up series AG4x (41, 42, 43) according to the protection type “flameproof” (Ex-d), supplied (connection room) and connected.

For the electronic and sensors the supply in Ex-d (in the connection room) is converted in Ex-ib, thereby intrinsically safe (Ex-ib) supplied and operated.

The identification for this combination is:  $\text{Ex}$  2G Ex d [ib] IIC T4

EMC protection can only be granted with shielded wires. The shielding must be grounded in the metal-PG-connecting bolts.

### 7.1.2 Start-up Instructions



- Start oval wheel meter with a gradually increasing flow rate.
- In measuring systems for viscous liquids which require heating, switch on the heating system of the oval wheel meter, filter and pipework in sufficient time prior to start-up; subsequently start up the device with a gradually increasing flow rate.

## 7.2. Environmental conditions

### 7.2.1 Ambient temperature

**USTD**                    -10° C to +70° C  
**USTX**                    -10° C to +60° C

## 7.2.2 Ambient temperature range

**USTD** -10° C to +70° C  
**USTX** -10° C to +60° C

## 7.2.3 Storing temperature

OaP: -20° C to +70° C

**USTD:** -20° C to +70° C  
OaP with **USTD:** -20° C to +70° C

**USTX:** -20° C to +60° C  
OaP with **USTX:** -20° C to +60° C

## 7.2.4 Climatic category

Class D IEC 654-1

## 7.2.5 Degree of protection

IP65 IEC 529 / EN 60529

## 7.2.6 Electromagnetic compatibility

DIN EN 61000-6-2; DIN EN 61000-6-3  
EU Directive: 2014/30/EU/UE

Electromagnetic compatibility may only be warranted when the electronics housing is closed. If the electronics housing is open, disturbances can arise due to electromagnetic interferences.

## 7.3. Process Conditions

### 7.3.1 Medium Temperature

	OaP 5	OaP 10	OaP 50	OaP 125	OaP 250
D2	< 170°C	< 170°C	< 170°C	< 170°C	< 170°C
L2	---	---	---	< 60°C	< 60°C
G2	---	---	< 170°C	< 170°C	< 170°C

	OaP 600	OaP 1200	OaP 2000	OaP 3200	OaP 4000
D2	< 170°C	< 170°C	< 170°C	< 170°C	< 170°C
L2	< 60°C	< 60°C	---	---	---
G2	< 170°C	---	---	---	---

### 7.3.2 State of aggregation

suitable for liquids

### 7.3.3 Viscosity

0.3 mPa·s - 3000 mPa·s

### 7.3.4 Medium temperature range

-10°C to +170°C

### 7.3.5 Medium pressure range

Depends on the material used (for materials, see section 8.3)

	OaP 5	OaP 10	OaP 50	OaP 125	OaP 250	OaP 600	OaP 1200	OaP 2000	OaP 3200	OaP 4000
<b>G2</b>	PN 25 PN40 PN 63 PN 100	PN 25 PN40 PN 63 PN 100	PN 25 PN40 PN 63 PN 100	PN 25 PN40 PN 63 PN 100	PN 25 PN40 PN 63 PN 100	PN 25 PN40	---	---	---	---
<b>D2</b>	PN25 PN40 PN63 PN 100	PN25 PN40 PN63 PN100	PN40 PN 63 PN 100	PN 25 PN40 PN 63 PN 100	PN 25 PN40 PN 63 PN 100	PN 25 PN40	PN 25 PN40	PN 25 PN40	PN 25 PN40	PN 25
<b>L2</b>	---	---	---	PN 25 PN40	PN 25 PN40	PN 25 PN40	PN 25 PN40	---	---	---



At temperatures higher than 50°C, the maximum pressure must be reduced according to the nominal pressure according to the tables "Pressure/temperature assignment" of the flange standard DIN EN 1092.



### 7.3.6 Pressure loss

Value in bar (for water)

OAP5	OAP10	OAP50	OAP125	OAP250	OAP600	OAP1200	OAP2000	OAP3200	OaP 4000
< 0.3	< 0.25	< 0.3	< 0.25	< 0.4	< 0.45	< 0.45	< 0.35	< 0.35	< 0.45

Normal toothed oval wheels

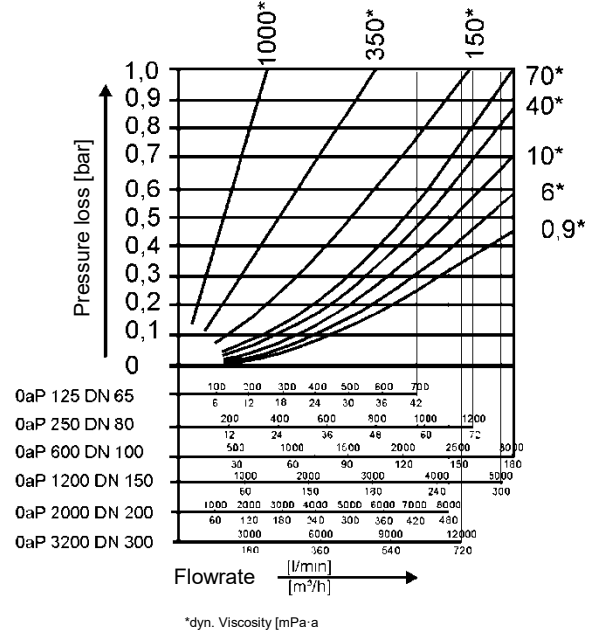
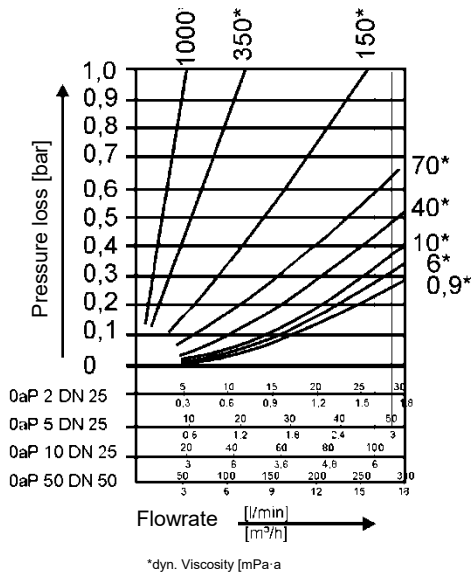

Special toothed oval wheels

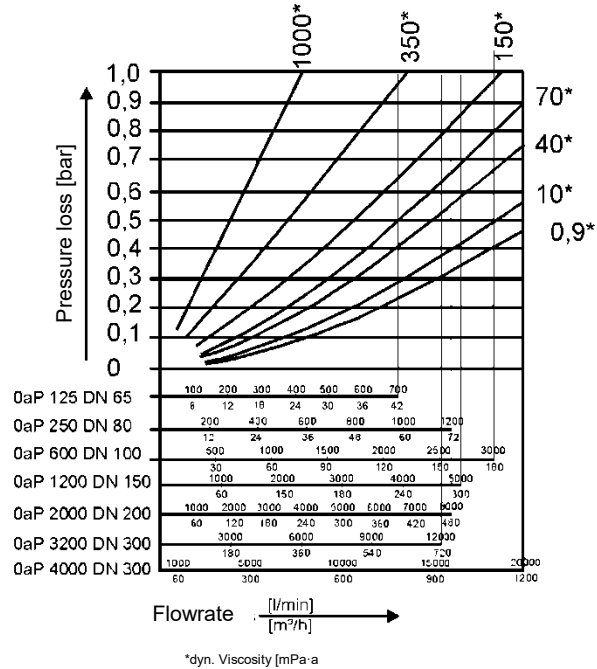
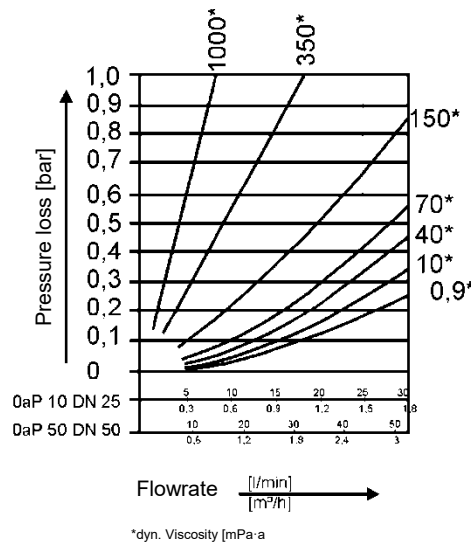

## 8. Construction details

### 8.1 Design/dimensions

Dimensions of OaP with pressure rating PN 16/25/40 / ANSI 150/300

	OAP5	OAP10	OAP50	OAP125	OAP250	OaP 600	OaP 1200	OaP 2000	OaP 3200	OaP 4000
<b>L</b>	220	220	325	450	550	650	800	900	900	1200
<b>h</b>	142	82	104	150	176	258	280	400	658	748
<b>H</b>	308	331	404	431	471	518	571	679	915	1003

Dimensions of OaP with pressure rating PN 63

	OaP 50	OaP 125	OaP 250	OaP 600	OaP 1200	OaP 2000
<b>L</b>	325	450	550	650	900	900
<b>h</b>	121	152	202	269	310	405
<b>H</b>	404	431	471	518	571	679

Dimensions of OaP with pressure rating PN 100 / ANSI 600

	OaP 5	OaP 10	OaP 50	OaP 125	OaP 250	OaP 600	OaP 1200
<b>L</b>	250	310	400	500	600	700	900
<b>h</b>	70	81	121	166	202	278	310
<b>H</b>	410	377	404	432	469	418	571

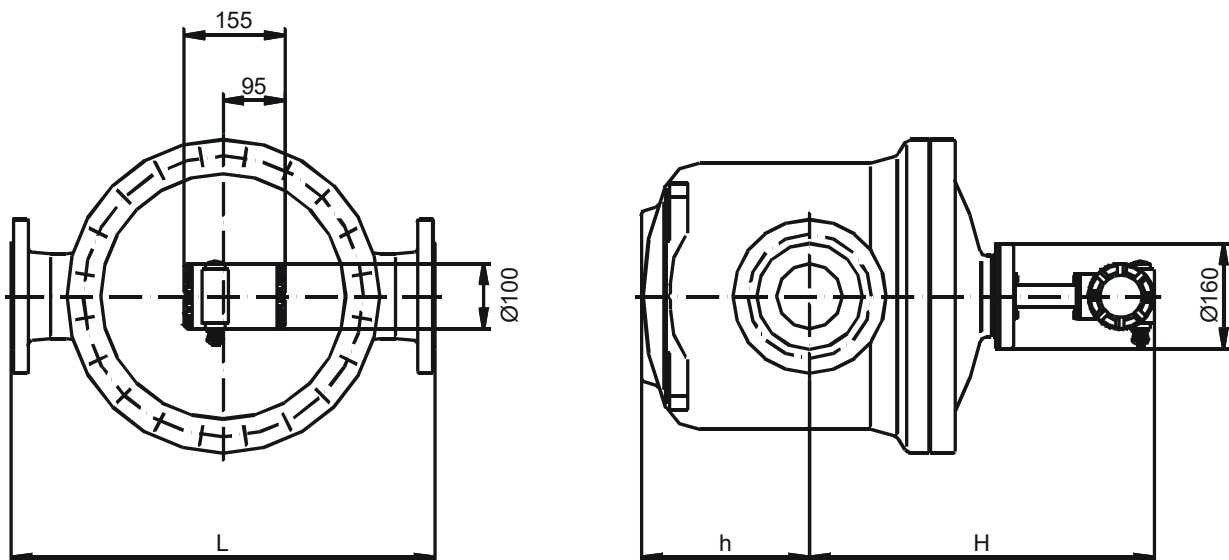

## 8.2 Weight

All weights are specified in kg.

The weight of OaP with pressure rating PN 16/25/40/63

OAP5	OAP10	OAP50	OAP125	OAP250	OAP600	OAP1200	OAP2000	OAP3200	OAP4000
19	27	61	80	155	260	509	894	1224	1924

The weight of OaP with pressure rating PN 100

OaP 5	OaP 10	OaP 50	OaP 125	OaP 250	OaP 600	OaP 1200
28	53	98	140	260	440	869

## 8.3 Material

	G2	D2	L2
<b>Measuring chamber</b>	Cast Iron	Cast iron	Light alloy
<b>Housing</b>	Cast steel	Cast steel	Cast steel
<b>Oval wheels</b>	Cast Iron	Cast iron	Light alloy
<b>Bearing</b>	Hard carbon	Cast iron	Hard carbon



Water applications with oval wheel meter type OaP is not possible.

The oval wheel meters are generally provided with a mineral oil resistant internal coating. For other medium, the suitability of the above coating is checked in each individual case.

## 8.4 Process Connection

OaP 5	OaP 10	OaP 50	OaP 125	OaP 250	OaP 600	OaP 1200	OaP 2000	OaP 3200	OaP 4000
25 1"	25 1"	50 2"	65 2,5"	80 3"	100 4"	150 6"	200 8"	300 12"	400 16"

Type plates with pressure relevant information

Additional type plate at the flange connection with CE0036 mark.

The used abbreviations have the following meaning:

PT: Achieved test pressure and test date

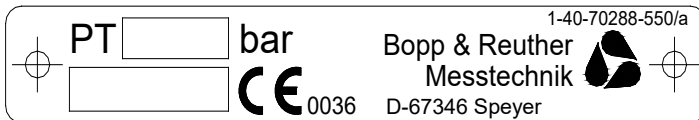

## 8.5 Electrical Connection

The electrical connections are located behind the cover of the shorter side of the housing.

Cable connection screws: M20 x 1.5 mm or NPT ½"

When you connect the transmitter is essential to ensure that the individual free wires are no longer than 50mm. This can be done by cutting the casing, an insulating tube or a cable tie just before the connecting terminal.

To operate the UST a 2-wire connection (terminals 1 and 2) is sufficient. This line serves three functions:

- Transmission of the analog signal representing the flow volume with 4-20 mA.
- Generation of auxiliary energy by the UST itself from the live zero with 4mA.
- Modulation of the FSK-signal (Frequency Shift Keying) on the current loop for digital data transmission according to HART®-specifications.

The outputs of the NAMUR-pulses are terminals 3 and 4. Not at **USTX!**

No further connections are required. For test purposes the connection circuit board is equipped with three soldering pins (see below) to which either a HART®-interface for data-transmission on-site or a measuring device in order to monitor the current can be connected.

There are several possibilities to connect HART®-communication, but the loop resistance must be within the values given under section 5.2. The HART®-interface can be connected to test-points TP2 and TP3 in the terminal connection area while the cover is open. If the HART®-interface is to be used at a different position in the loop it can be connected to points X-Y or X-Z. However it must not be connected directly to the power supply device at point Y-Z.

In the below figure, the connections of the HART®-communicator can be interchanged with those of the PC or laptop.



When installing in hazardous areas, the respective national installation regulations must be observed (for Germany: EN 60079-14 or VDE 0165).

## OaP with UST

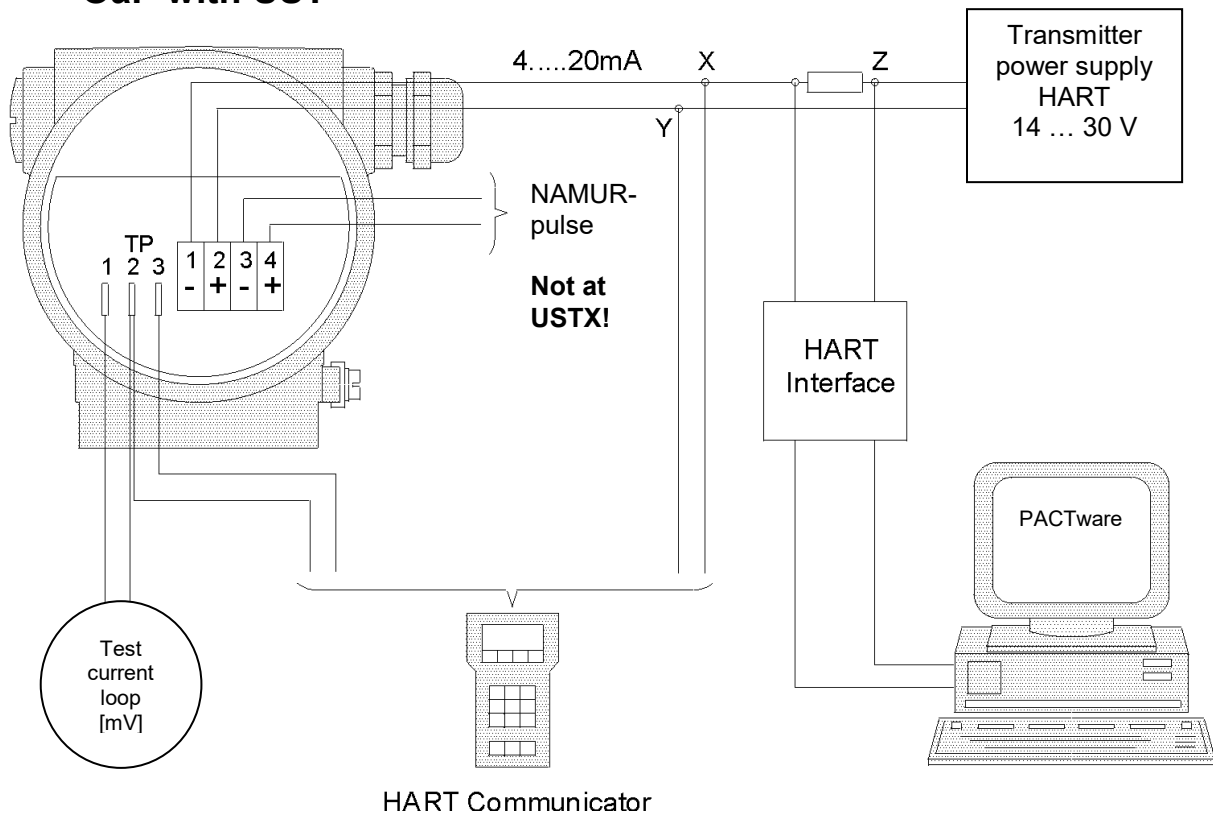

### 8.5.1 Operation with PACTware Software

To operate the UST's with the PACTware operating software a HART®-Interface is required. The Interface transforms the level of the RS232 interface or USB- interface into a frequency shift keying (FSK) signal. The interface can also be installed permanently. The connection is shown in the above figure under Section 8.5.

	<p>The use of a PC or a Laptop and HART® - interface in an Ex-Zone requires a special approval certificates.</p>
---	--

## 9. Display and user interface

### 9.1 General

The meters are set before delivery according to the operating conditions specified in your order. For further information please refer to attached configuration data sheet.

For the configuration respectively the operation of the transmitter you have the choice between the following two options:

1. HART®-ommunication
2. On-site control of simple functions by means of a switching magnet.

### 9.2 LC - Display

The flow rate, the sum and the reset counter can be displayed on the 8-digit LCD display. The displayed value is selected via the switching magnet, which is operated by touching the "Display" button below the display window. The value chosen is identified by a line below the decimal point. After pressing the button the display switches as shown in the overview below:

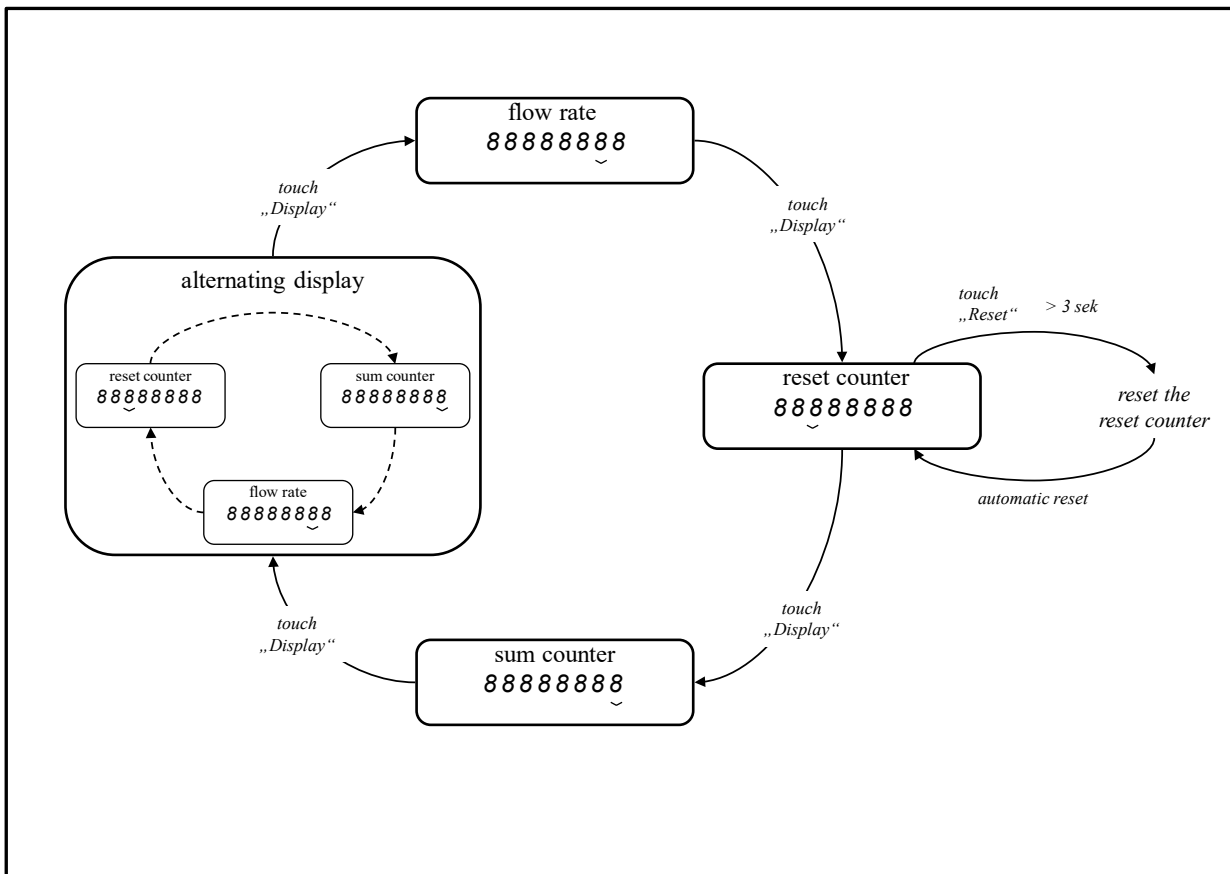

In the alternating display mode all three indications are activated sequentially at preset time intervals. The resetting of the reset counter can only be effected while this specific value is being displayed. The contact must be actuated for at least three seconds. For better legibility the display circuit board may be rotated mechanically by 90° or 180° (see also Appendix B3).

### 9.3. Operation with HART®-communication

#### 9.3.1 PACTware

To operate the oval wheel meter with UST the PACTware software can be used. PACTware is a configuration- and operation software that provides all UST-functions via HART® -communication. The individual functions are listed in section 9.4 "Device functions and parameter". A PC is required for the use of PACTware. The requirements are described at the homepage of the PACTware Consortium

([www.pactware.com/fileadmin/user\\_upload/Version-Overview/2022-02-20\\_PW\\_Versionshistorie\\_en\\_fin\\_01.pdf](http://www.pactware.com/fileadmin/user_upload/Version-Overview/2022-02-20_PW_Versionshistorie_en_fin_01.pdf))

The software is free to download: <https://www.bopp-reuther.com/en/download/> software.

UST is connected to the RS232 or USB-interface of the PC using a HART® -interface (see section 8.5.1).

#### 9.3.2 HART®-communicator

A HART®-communicator handheld (e.g. from Emerson) is another operating element which can be used. The operating functions for communicator are defined in a DD (Device Description). Using a communicator handheld it is possible to operate or configure the UST on-site. The connection is described in Appendix C.

The Device Description Language (DD) can be downloaded from the Internet (HART® Foundation <https://www.fieldcommgroup.org/registered-products>).

## 9.4 Device functions and parameter

### 9.4.1 Measuring values

- **Volume flow:** Display of the actual volumetric flow in the selected unit.
- **Flow unit:** Units to define the volumetric flow. Options are: l/s, l/min, l/h, m<sup>3</sup>/s, m<sup>3</sup>/min, m<sup>3</sup>/h, gal/s, gal/min, gal/h, imp gal/s, imp gal/min, imp gal/h, ft<sup>3</sup>/s, ft<sup>3</sup>/min, and ft<sup>3</sup>/h.
- **Reset counter:** The reset counter adds up the volume values measured in the selected unit and can be reset. After a power outage the counter is automatically reset to zero.
- **Sum counter:** The sum counter adds up the volume values measured in the selected unit. This counter can only be reset when being serviced. The value displayed does not change after a power outage.
- **Unit of volume:** This unit defines the value of the reset and the sum counter. If this unit is changed during operation, the new volume units are added up to the old volume units. Therefore please set the counters to zero before changing the unit. Choose between l, m<sup>3</sup>, gal, impgal, ft<sup>3</sup>.
- **Frequency history:** The maximum sensor frequency is recorded. The display cannot be set to zero or altered (drag hand function) and remains unchanged after a power outage.
- **Pulse meter:** The pulse meter displays the number of all original pulses without evaluation. The display cannot be set to zero and remains unchanged after a power outage.

### 9.4.2 Output

- **End value of measuring range:** The end sensor value is pre-set in the UST of all meters regardless of the series. This value must not be exceeded during operating.
- **Initial value of measuring range:** The initial sensor value is pre-set in the UST of all meters regardless of the series. Below this value there is no defined error curve.
- **Minimum measuring span:** The minimum measuring span can be set as desired within the measuring range. The minimum measuring span should be maintained as a lower value can lead to fluctuations of the output current.
- **Lower range value (LRV) of current output:** The desired initial flow value in the selected unit is assigned to the initial value of 4 mA. Usually the flow value of zero is assigned to 4 mA.
- **Upper range value (URV) of current output:** The desired final flow value in the selected unit is assigned to the final value of 20 mA.
- **Attenuation:** Attenuation affects the output current and the flow rate display. Choose a value between 1 s and 200 s. The resolution is approx. 1 s.
- **Current alarm:** When the current alarm is activated the current output is set to 22 mA, as soon as a current alarm occurs.
- **Pulse output:** The pulse output can either be set as original pulse with the frequency and pulse value corresponding to the K-factor of the meter or as a scaled pulse with a pulse value and pulse width that can be scaled in decade steps.

### 9.4.3 Device Parameter

- **Sensor type:** Indicates to which sensor type (Wiegand, Reed or inductive pick-up) the electronics are set.
- **K<sub>p</sub> Factor:** The test factor is device specific and cannot be changed. It is defined during the calibration process; the unit is pulses/l.
- **K<sub>K</sub> Factor:** The correction factor is without dimension and serves to adjust the error curve to various medium. The factor can be adjusted by the servicing staff. Thus viscosity correction is possible.
- **K<sub>B</sub> Factor:** The operating factor is the product of test factor and correction factor. This factor is not stored in the UST but calculated and displayed with PACTware.

- **Display mode:** The display can be switched between flow rate, reset counter and sum counter. The three values are shown alternately at intervals of about 2 seconds (see section 9.2).
- **Pulse value factor:** The values of the output pulses and of the meter are set using the pulse value factor  $F_w$ . Together with the selected unit the pulse value factor corresponds to the pulse value and to the increment of the meter.

$$1 \text{ pulse} \hat{=} \underbrace{0,1}_{\text{Factor}} \cdot \underbrace{l}_{\text{Unit}}$$

*value*

Example: pulse value factor 0.1 means:

When the factor is set, the display automatically adjusts the decimal point accordingly so that the values can be read directly from the meter.

The pulse value factor can be set as follows:

Pulse value factor	1	0.1	0.01	0.001
--------------------	---	-----	------	-------

If this factor is changed during operation the meters should be set to zero as otherwise mixing various volume evaluations will lead to incorrect figures. Please make sure that the maximum output frequency is not exceeded, which depends on the selected pulse width (see table “pulse width” below). If the output frequency is exceeded, the excessive pulses are counted into a buffer memory; the output is affected with a time delay.

- **Pulse Relation Factor:** Using the pulse relation factor  $F_i$  ratio the meter and the pulse output can be evaluated differently. The pulse relation factor is the relation of the value of the meter increment and the value of the pulse output.
- **The standard setting is  $F_i = 1$ , i.e. one increment on the meter corresponds to one pulse output.**
- If the factor is set to  $F_i \neq 1$  the value of the pulse output is changed whereas the value of the meter remains unchanged. The maximum output frequency must be checked.
- **Pulse Width:** Choose the pulse width according to the table below:

Pulse width	150 ms	50 ms	20 ms	10 ms
Maximum output frequency	3.3 Hz	10 Hz	25 Hz	50 Hz

This setting applies to both pulse outputs, i.e. current pulse and NAMUR pulse. NAMUR not at USTX!

The maximum output frequency has to be taken into account when choosing pulse value and pulse relation factor (see section 9.5 calculation examples).

#### 9.4.4 Dialog / Functions

- **Reset of the reset counter:** The reset counter can be reset to zero at any time.
- **Reset sum counter:** The sum counter may only be reset by our service staff. If the units of the volume or the pulse value are changed, this meter has to be reset to zero.
- **Current simulation:** For testing serially connected devices a fixed output current may be set. After testing the current value 0 mA must be entered to end the simulation.
- **Calibration of Current Output:** The characteristic curve of the analog current output may be calibrated at 4 mA for the zero point and at 20mA for the end value. Please note that the zero point has to be calibrated before the end value.



### 9.4.5 HART®

- **Software version:** The number indicates the version of the UST software.
- **Hardware version:** The number indicates the version of the UST hardware.
- **Polling Address:** If the UST is to be installed for multi-drop application a polling address from 1 – 15 must be entered. This means that a point-to-point connection with the desired address has to be configured beforehand. If the polling address is set to zero the operation is analog.

### 9.5 Checking the maximum output frequency of the pulse output

to ensure that the maximum output frequency is not exceeded observe the following

for  $F_i=1$ ,  $F_w \triangleq W_{count}=W_{pulse}$  the following applies:

$$F_w \geq \frac{Q_{max}}{f_{max}}$$

for  $F_i \neq 1$ ,  $F_w \triangleq W_{count}$  the following applies:

$$F_w \geq \frac{Q_{max}}{f_{max}} \cdot F_i$$

and

$$W_{puls} = \frac{W_{count}}{F_i}$$

#### Meaning of formula symbols:

$Q_{max}$ : maximum flowrate  $\left[ \frac{\text{selected unit}}{\text{second}} \right]$

$f_{max}$ : max. output frequency (see table)

pulse width	150 ms	50 ms	20 ms	10 ms
max. output frequency	3.3 Hz	10 Hz	25 Hz	50 Hz

$F_w$ : pulse value factors

pulse value factor	1	0.1	0.01	0.001
--------------------	---	-----	------	-------

$F_i$ : pulse relation factor

$W_{count}$ : counting value in l, m<sup>3</sup>, etc.

$W_{pulse}$ : pulse value in l, m<sup>3</sup>, etc.

#### Calculation examples to check the scaled pulse output taking into account the maximum output frequency

1. Example  
for a selected pulse width of 150 ms the maximum output frequency is  $f_{max} = 3.3$  Hz.

- selected volume unit [l]

- maximum flow rate (e.g. OaP 5)  $Q_{max} = 0.83$  l/s

The smallest possible pulse value factor is calculated as follows:

$$F_w \geq \frac{Q_{\max}}{f_{\max}} = 0.83 / 3.3 = 0.25$$

According to the table (see section 9.5 pulse value factors) for the pulse value factors

$$F_w = 1$$

the next larger value or the same value must be selected.

Thus the value of the meter and the pulse output is 1 l, i.e. 1 l per pulse.

- The same meter data as in example 1 are assumed, but the value on the meter is to be one tenth of the value of the pulse output (meter is 10 times faster). A pulse relation factor of 0.1 needs to be set.

The smallest possible pulse value factor is calculated as follows:

$$F_w \geq \frac{Q_{\max}}{f_{\max}} \times F_i = 0.83 / 3.3 \times 0.1 = 0.025$$

The next larger value must be selected, i.e.:

$$F_w = 0.1$$

The pulse value of the pulse output is calculated as follows:

$$W_{pulse} = \frac{W_{count}}{F_i} = 0.1 / 0.1 = 1 \text{ l} \quad (\text{for } F_i \neq 1 \text{ ist } F_w \hat{=} W_{count})$$

Higher pulse values can be selected by setting the pulse value factor to a higher decimal level.



The maximum output frequency will be exceeded, if the pulse value factors are smaller than the calculated critical value.

## 10. Connection of the Universal Smart Transmitter UST

### Power supply

The supply voltage is within 14 - 30 VDC and must not exceed

30 V DC at **USTD**

28 V DC at **USTX**

Cable connection screws	:	M20 x 1.5
Cable diameter	:	6 - 12 mm
Terminals	:	GKDS Ex
Core cross section	:	0.2 - 2.5 mm <sup>2</sup>



When the transmitter is connected, it is essential to make sure that the individual free wires are not longer than 50 mm. This can be done by cutting the sheath to length, an insulating tube or a cable tie immediately before the connection terminal.

## 11. 10-points linearization

The linearization feature of the UST is one of the useful features among others. With the 10 points linearization function, the shape of the error curve of the flowmeter can be well corrected mathematically and the repeatability capabilities of the flow meter be used in an optimal manner.

In normal operation, the UST calculates its flow value from a single K-factor determined during calibration. Once linearization points are stored in the UST, the normal K-factor is no longer used, but the K-factor resulting from the linearization from the current flow.

To determine the linearization points itself, the meter must be measured on a calibration stand. From this, the respective K-factor at different flow rates or frequencies is determined.

The linearization points can only be transferred to the UST electronics via the PACTware software. A HART®-modem is required for the transfer.

The software can be downloaded free of charge from our homepage. Please install the program "PACTware" and the device driver "DTM UST". You will receive a free license from our sales department to use the linearization function.

The UST can store up to 10 linearization points. Each point consists of a flow value and K-factor such as Q1: K1, Q2: K2, up to Q10: K10. The actual flow rate is Q. At  $Q < Q_1$ , K-factor K1 is selected. When  $Q_1 < Q < Q_2$ , linear interpolation is used between K1 and K2. Similarly, when  $Q_2 < Q < Q_3$ , linear interpolation is used between K2 and K3. For  $Q_{10} < Q$ , K10 is used.

The following graph shows the performance that the instrument can meet after making use of this functionality.

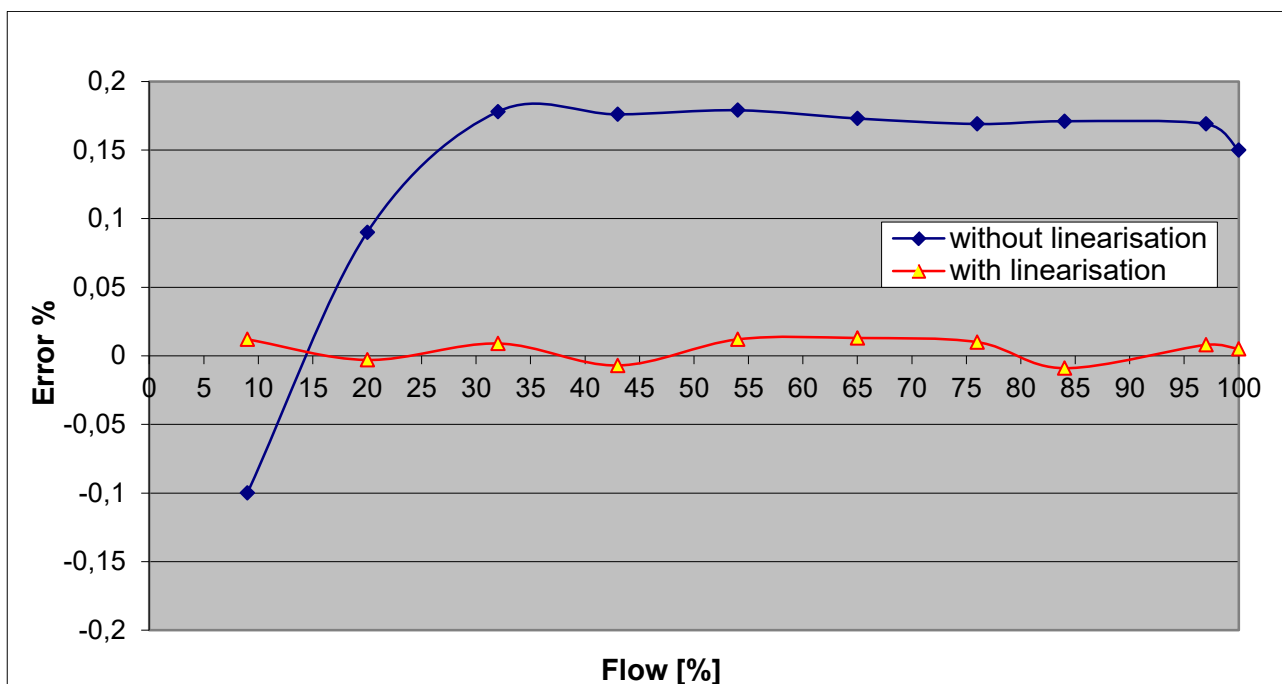

## Appendix

### A. Trouble shooting and debugging

The oval wheel meter and the UST do not require servicing. If a malfunction or incorrect measuring occurs, the following instructions offer help to identify the cause of possible errors and information for debugging.

	<p>When working on the electrical connections, the local regulations and all safety instructions in this operating manual must be observed.</p>
---	---

For Ex-devices, all information and regulations from the Ex-documentation must be observed in addition to the above.

	<p>For some tests, it is necessary to remove the UST electronics from the casing. To do so, unscrew the cover and remove the face of the counter so that you can loosen both diagonally opposite cylinder head screws on the circuit board. The screws have a plastic washer at the end to prevent them from falling out. Please take care to not loosen the two plastic washers.</p>
---	---

The following section describes the possible malfunctions and the necessary measures for its remedy.

#### A.1 Fault in the electronic transmitter

##### No LCD display:

Check the current loop, the load and the voltage supply. The supplied voltage should be between 14 VDC and 30 VDC at **USTD** resp. 28 VDC at **USTX**. The maximum load is based on the supply voltage (see section 5.2)

##### No flow information on the LCD:

If a “zero” flow is shown although there is a flow check the coding on the jumpers above the LCD according to the following diagram. To do so, first remove the dial face (see section 9.4.3: Type of sensor).

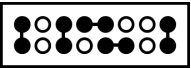
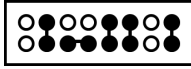
Coding	Sensor	Type
	Type Reed	AG 5x
	Type Wiegand	AG 4x

The sensor pulse can be checked at the terminals on the supply board. Depending on the design, the terminals Reed (no. 5 and 6) or W/I (no. 7 and 8) are used. At the terminals of the Reed contact a pulse of approx. 5 V can be measured. The Wiegand pulse has amplitude of approx. 200 mV to 400 mV with a pulse width of 20µs to 50µs.

The below image shows the overall and the magnified view of the connection terminals of UST.

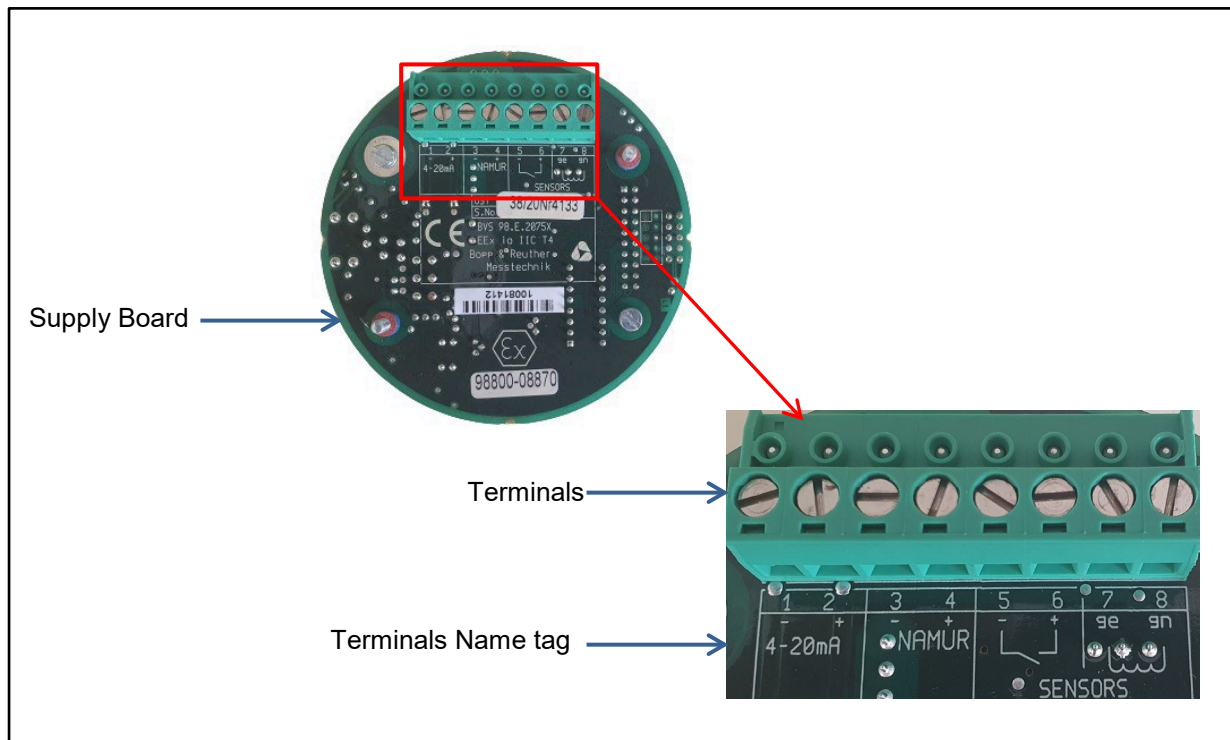

#### Volume counter cannot be deleted:

With the Reed "RESET" above the display only the reset counter may be reset to zero, not the sum counter. The reset counter can only be reset if this display mode is active. The display mode may be changed by means of the HART®-protocol or with the "DISPLAY" Reed below the display. Actuate > 3 seconds.

#### Current output does not function correctly:

If the value of the output current deviates from the theoretical reference value, the supply voltage and the maximum load limits must be checked. A load which is too large may result in a substantial decrease of the terminal voltage for the UST. The calibration of the 4 mA and the 20 mA points of the output characteristic curve must be checked, too. If the current output does not show analog values check the positioning of switch on the supply circuit board. (see also diagram in section 5.1.2.1)

#### Pulse output does not function correctly:

If the UST current pulse output is used the double actuator must be set correctly (see diagram in section 5.1.2). The current pulse is available at terminals 1 and 2, the NAMUR-pulse at terminals 3 and 4! If the high level is lower than 20 mA check the supply voltage and the load (see section 5.2).

#### Pulse output at zero flow rate:

If pulses are transmitted to the pulse output although there is no flow rate check pulse value, pulse relation factor and pulse width. If a large pulse width has been selected, the output of the pulses is processed rather slowly. If the factors have been selected in such a way that the theoretical output frequency is significantly higher than the maximum possible frequency, the excess pulses are stored. The overflow memory then sends signals with a maximum frequency even if the flow is zero until the memory is empty. Thus no volume pulses are lost.

#### Counter increments are too small:

Check the volume rate unit,  $K_P$ -,  $K_K$ - and pulse value factors as well as the decimal point.

#### Counter increments are too high:

Check the volume rate unit,  $K_P$ -,  $K_K$ - and pulse value factors as well as the decimal point.

**Output current is over 20 mA:**

The flow of the oval wheel meter is larger than the maximum limit value of the measurement output. The range end must be increased accordingly.

**Output current remains at 4 mA for small flow rates:**

The minimum limit value of the measurement output is set at a value that is too high. The minimum limit value must be reduced accordingly.

**Output current fluctuates significantly:**

The revolutions of the oval wheel meter or the pulse frequency are low. The minimum measuring range has not been reached. Attenuation of > 1s may result in a smoothing.

**Displayed flow rates are too high:**

Check the volume rate unit,  $K_P$ -,  $K_K$ - and pulse value factors.

**Displayed flow rates are too small:**

Check the volume rate unit,  $K_P$ -,  $K_K$ - and pulse value factors.

**Data transmission does not function properly:**

The minimum load must be attained for reliable communication. The optimal minimum loop resistance is about 230  $\Omega$ . If the load is higher a sufficiently high supply voltage must be available (see section 5.2).

**Data transmission not possible:**

The UST must be connected by means of a point-to-point connection. Only one master may access the interface. The multi-drop address must be set to 0. Loop resistance and supply voltage must be within the limits given in diagrams 1 and 2. With these settings communication should be possible.



If the cause of a malfunction cannot be identified please contact the Bopp & Reuther Messtechnik service or send the device to the headquarter in Speyer for repair (see Appendix B1).

## B Maintenance, cleaning and changing the Display

### B.1 Maintenance, Cleaning

If the oval wheel meter is put out of operation for a longer period of time it has to be dismantled, thoroughly cleaned and protected with acid-free oil. Oval wheel meters used for liquid food must not be prepared for conservation in this manner. In- and outlet must be covered with caps. Make sure to store the oval wheel meter in a dry room.

#### Cleaning the oval wheel meter (e.g. for food)

The oval wheels have to be dismantled if the pipes are flushed with hot water.

- Loosen tommy nuts of the casing cover, lift-off casing cover with pressure screws, pull off oval wheels one by one from their shaft, handle with great care, do not place on stone floors, rather use a rubber pad or a wooden board.
- When assembling the oval wheels position them and make them mesh such that the marking points (M) on the faces match. Turn the oval wheel manually to make sure they are properly inserted (one revolution). When placing the gasket, make sure that it is seated properly.

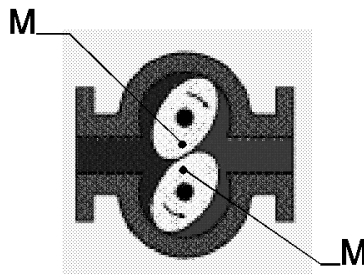

### B.2 Repair / hazardous material

Before sending the oval wheel meter to Bopp & Reuther Messtechnik, make sure to observe the following:

- Attach a note describing the malfunction, state the application field and the chemical/physical properties of the medium (please find the respective form in Appendix D).
- Remove all residues of the medium and pay special attention to sealing grooves and slits. This is of special importance if the medium is hazardous to health, i.e. caustic, toxic, carcinogenic or radioactive etc.
- Please do not return the device if you are not perfectly sure that all medium hazardous to health have been cleaned off.

Costs incurred due to inadequate cleaning of the device and possible costs for disposal and/or personal injuries (burns, etc.) will be billed to the operating company.

Please ask our customer service for help and advice if your oval wheel meter does not work properly:

Bopp & Reuther Messtechnik GmbH  
Service  
Am Neuen Rheinhafen 4  
67346 Speyer, Germany  
Phone: +49 6232 657-420  
Mob.: +49 15115233023  
Fax: +49 6232 657 561  
Email: [service@bopp-reuther.com](mailto:service@bopp-reuther.com)

### B.3 Rotating the display

If you want to change the display direction of the standard model, the LCD can be rotated in 90° steps by our service personnel or by yourself. Remove the cover with the pane of glass and unscrew the fastening screws of the dial face. If you want to rotate the display by 180° you only need to remove the electronics block and rotate it. If you want to rotate the display 90° you must remove the electronics block and the mounting plate below and rotate both. All assembly work may only be performed off-circuit.

### B.4 Rotating the housing

Rotating the housing might be advantageous for some applications (e.g. vertical installation of the oval wheel meter). The connection between the housing and the spacer tube may be loosened and turned. Make sure that the sensor wires are not damaged.

## C. Application examples

### C.1 Application example 1: USTD / USTX

- application in non-hazardous areas
- for application in hazardous areas (Ex d)

**When USTX: no terminals 3 and 4!**

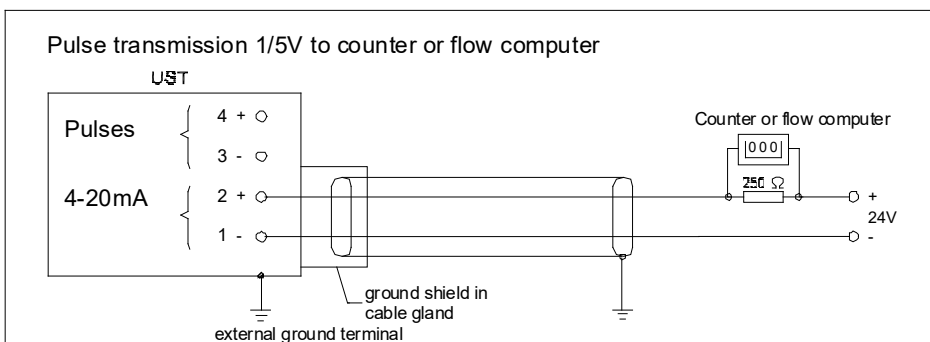
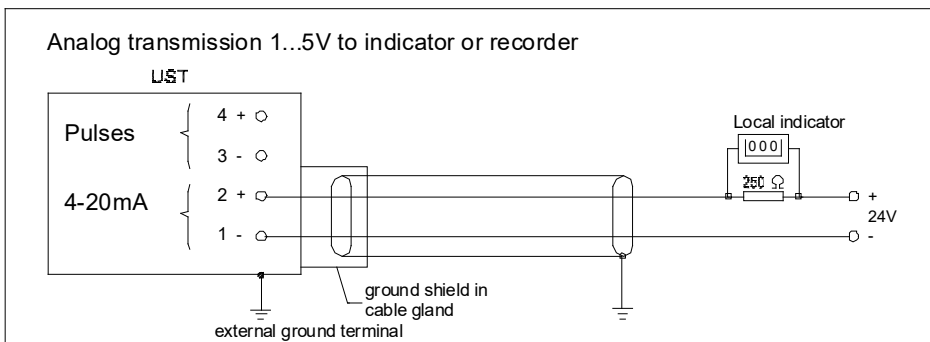
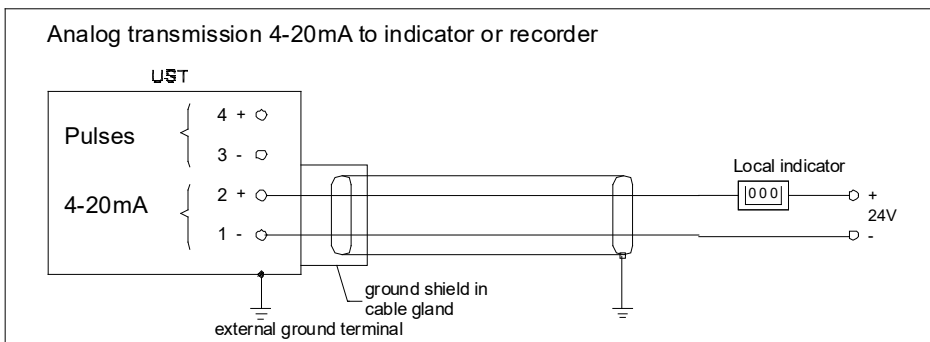
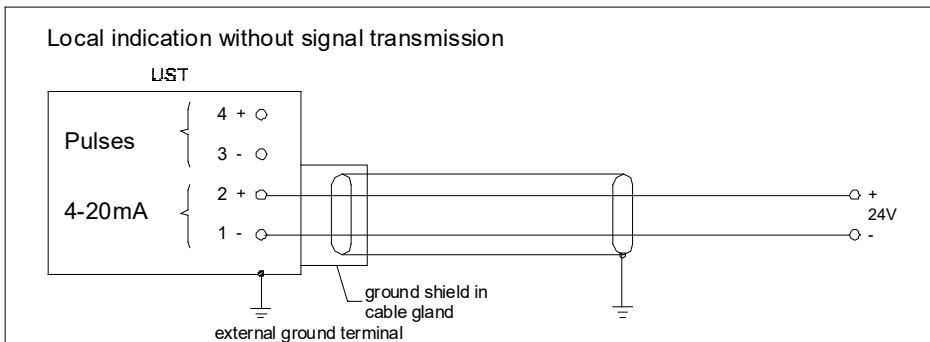



### C.2 Application example 2: USTD / USTX

- application in non-hazardous areas with HART®
- for application in explosion hazardous areas (Ex d) with HART®

**When USTX: no terminals 3 and 4!**

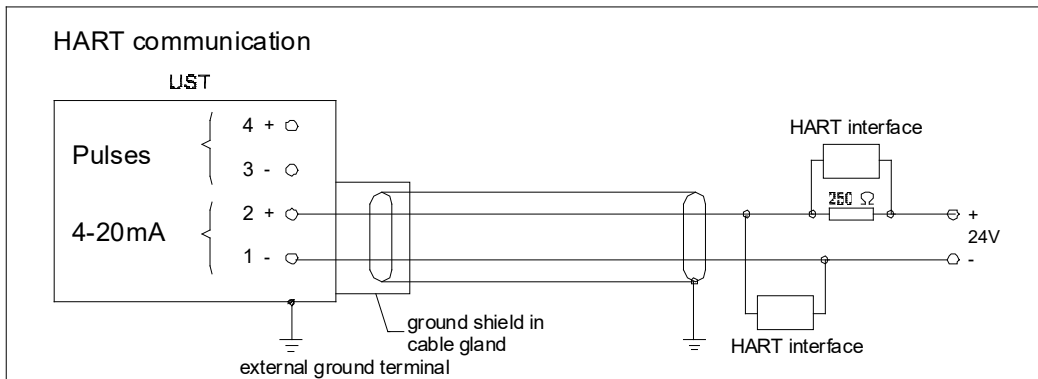

### C.3 Application example 3: USTD

- application for the pulse output acc. to NAMUR in non-hazardous areas
- application for the pulse output acc. to NAMUR in hazardous areas

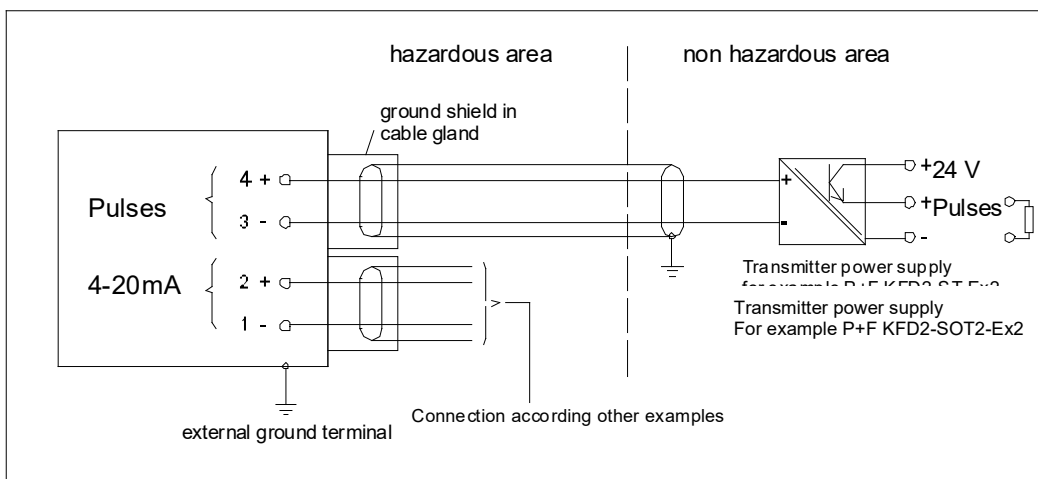

For Ex safety reasons at the **USTX**, the negative pole of the terminal is earthed to the housing for this type of connection circuit. This can lead to interference with several 4-20 mA current loops. In this case, a passive isolator, e.g. IsoTrans 36 from Knick, should be applied.

### D. Declaration on Decontamination

**Bopp & Reuther Messtechnik GmbH**  
 Am Neuen Rheinhafen 4  
 67346 Speyer  
 Germany

**BOPP & REUTHER  
 MESSTECHNIK** 

Telephone: +49 (0) 6232 / 657 420  
 Fax: +49 (0) 6232 / 657 561  
 Mail: [service@bopp-reuther.com](mailto:service@bopp-reuther.com)  
 Web: [www.bopp-reuther.com](http://www.bopp-reuther.com)

ERA number:

#### DECLARATION ON DECONTAMINATION OF METERS AND COMPONENTS

Please complete this form and return in advance by email or by Fax to +49(0)6232 / 657 561 in order to receive an Equipment Return Authorisation (ERA) number (not necessarily required). No action to repair or examine the meter will be done, until a valid declaration of decontamination has been received.

##### Contact information

Company Name:	<input type="text"/>	Contact Person:	<input type="text"/>
Company Address:	<input type="text"/>	Name:	<input type="text"/>
		Phone:	<input type="text"/>
		Email:	<input type="text"/>









##### Meter information

Type:	<input type="text"/>	Serial no.:	<input type="text"/>
Id. no.:	<input type="text"/>		

Reason for return (e.g. calibration, repair). Please describe in detail.

##### Contamination information

The meter was contaminated with:

<input type="checkbox"/> poisonous 	<input type="checkbox"/> corrosive, irritant 	<input type="checkbox"/> flammable 
<input type="checkbox"/> hazardous 	<input type="checkbox"/> oxidizing 	<input type="checkbox"/> cancer-causing, harmful 
<input type="checkbox"/> explosive 	<input type="checkbox"/> environmental hazardous 	<input type="checkbox"/> other: <input type="text"/>

The meter was cleaned with:

##### Packaging and shipping Instructions

- Remove all cables, connectors, separate filters and mounting materials
- Please pack each item in two suitable sealed protective foil bags
- Transport in suitable shipping package (e.g. original Bopp & Reuther Messtechnik shipping package)
- Include a copy of this declaration form along with the shipping documents on the outside

By signing this form, you are accepting the full responsibility for its contents and confirming that appropriate decontamination has taken place in accordance with legal regulations.

Print name:  Date:

Legally valid signature:

## E. Certificates

### E.1 Explosions protection certificates

#### E.1.1 USTD: EC Type Examination Ex-Approval DMT 00 ATEX E 025 X

see Homepage: <https://www.bopp-reuther.com/en/download/> EC Type Examination Ex-Approvals  
Bopp & Reuther Messtechnik.

#### E.1.2 USTX: EC Type Examination Ex-Approval BVS 04 ATEX E 022X

see Homepage: <https://www.bopp-reuther.com/en/download/> EC Type Examination Ex-Approvals  
Bopp & Reuther Messtechnik.

### E.2 Pressure Equipment Directive:

#### E.2.1 Conformity to Type:

see Homepage <https://www.bopp-reuther.com/en/download/> to download the latest certificates.

E.2.2 EU Type Examination Certificate

ZERTIFIKAT ◆ CERTIFICADO ◆ CERTIFICAT ◆  
 認証証書 ◆  
 ◆ CERTIFICATE ◆



TUV  
SUD  
Industrie Service

# ZERTIFIKAT

gültig bis: 22.07.2029

# CERTIFICATE

valid until: 22.07.2029

**EU-Baumusterprüfung (Modul B) - Baumuster - nach Richtlinie 2014/68/EU**

*EU Type examination (module B) - production type - according to Directive 2014/68/EU*

<b>Zertifikat-Nr.:</b>	<b>Z-IS-AN1-MAN-19-07-2681356-23083220</b>
<i>Certificate No.:</i>	
<b>Name und Anschrift des Herstellers:</b>	<b>Bopp &amp; Reuther Messtechnik GmbH</b>
<i>Name and address of manufacturer:</i>	<b>Am Neuen Rheinhafen 4 67346 Speyer</b>

**Hiermit wird bescheinigt, dass das unten genannte Baumuster die Anforderungen der Richtlinie 2014/68/EU erfüllt.**

*We herewith certify that the type mentioned below meets the requirements of the Directive 2014/68/EU.*

## CE 0036

<b>Prüfbericht Nr.:</b>	<b>P-IS-AN1-MAN-19-07-2681356-23083220</b>
<i>Evaluation report No.:</i>	
<b>Geltungsbereich:</b>	<b>Ovalradzähler der Typen OI, OUI, OaP, OuaP, OV, OK, OT, OKT, OF, OR, OC, OP, DN 50 - 400, PN 10 - 100</b>
<i>Scope of examination:</i>	

<b>Fertigungsstätte:</b>	<b>Bopp &amp; Reuther Messtechnik GmbH</b>
<i>Manufacturing plant:</i>	<b>Am Neuen Rheinhafen 4 67346 Speyer</b>

**Mannheim, 23.07.2019**  
**(Ort, Datum)**  
*(Place, date)*

Echtheitsprüfung durch App TÜV SÜD Verify  
*Verification of Certificate by TÜV SÜD App Verify*



**TÜV SÜD Industrie Service GmbH**  
**Zertifizierungsstelle für Druckgeräte**

*Ralf Brinkmann*  
**Ralf Brinkmann**

+49 621 395-367

Notifizierte Stelle, Kennnummer 0036  
Notified Body, No. 0036  
TÜV SÜD Industrie Service GmbH  
Westendstr. 199  
80686 München  
GERMANY

Dokument ID: 2681356Y8193f



Seite 1 zum Zertifikat Nr. / Page 1 of the certificate No. Z-IS-AN1-MAN-19-07-2681356-23083220

## E.3 EU – Declaration of conformity

**EU - Konformitätserklärung**  
**EU - Declaration of conformity**  
**UE - Déclaration de conformité**

Hiermit erklärt der Hersteller in alleiniger Verantwortung, dass die nachfolgend bezeichnete Baueinheit den Anforderungen der zutreffenden EU-Richtlinien entspricht. Bei nicht mit uns abgestimmten Änderungen verliert diese Erklärung ihre Gültigkeit.

*The manufacturer herewith declares under sole responsibility that the unit mentioned below complies with the requirements of the relevant EU directives. This declaration is no longer valid if the unit is modified without our agreement.*

Par la présente, le fabricant déclare sous sa seule responsabilité que les appareils décrits ci-dessous, correspondent aux exigences de la réglementation UE qui les concerne. Toute modification des appareils sans notre accord entraîne la perte de validité de cette déclaration de conformité

<b>Hersteller</b> Manufacturer Fabricant	Bopp & Reuther Messtechnik GmbH Am Neuen Rheinhafen 4 D-67346 Speyer
<b>Bezeichnung</b> Description Description	Ovalradzähler Ovalwheel meter Compteur à roues ovales
<b>Typ, Modell</b> Type, model Type, modèle	OI / OUI / OaP / OUaP / OK / OP mit with avec UST, AG, MFE, IG, SE, KSE, KSN, NK

<b>Richtlinie</b> Directive Directive	2014/30/EU /UE Elektromagnetische Verträglichkeit Electromagnetic interference Compatibilité électromagnétique	L 96/79
<b>Normen und normative Dokumente</b> Standards and normative documents Normes et documents normatifs	EN 61000-6-2:2005 EN 61000-6-3:2012	

<b>Richtlinie</b> Directive Directive	2014/34/EU /UE Explosionsschutz Explosion protection Protection contre les explosions	L 96/309
<b>Baumusterprüfbescheinigung</b> Type examination certificate Certificat d'approbation de type	DMT 99 ATEX E 014 X DMT 00 ATEX E 025 X BVS 04 ATEX E 022 X DMT 00 ATEX E 063 X PTB 99 ATEX 2219 X TÜV 15 ATEX 131621 X BVS 09 ATEX E 031 X BVS 00 ATEX 2048 X EPS 14 ATEX 1766 X	USTI USTD USTX AG43-45 (PV11) AG19-20, IG (SJ3,5-N) AG01-08 (01-08) MFE1-3 KSN (NJ1,5-6,5-N) KSE, NK (07-2511)
<b>Notifizierte Stelle</b> Notified Body Organisme Notifié	BVS, DMT: DEKRA EXAM PTB TÜV, EPS: Bureau Veritas	0158 0102 0044
<b>Normen und normative Dokumente</b> Standards and normative documents Normes et documents normatifs	EN IEC 60079-0:2018 EN 60079-1:2014 EN 60079-11:2012 EN 60079-26:2015	USTI, USTD, USTX, PV11, SJ3,5-N, 01-08, MFE1-3, NJ1,5-6,5-N, 8064/21 USTD, USTX, 01-08, 8064/21 USTI, USTD, USTX, PV11, SJ3,5-N, MFE1-3, NJ1,5-6,5-N USTI

Bopp & Reuther Messtechnik GmbH, Am Neuen Rheinhafen 4, 67346 Speyer / Germany  
 Telefon: +49(0)6232 657-0, Telefax: +49(0)6232 657-505, Email: [info@bopp-reuther.com](mailto:info@bopp-reuther.com), Internet: [www.bopp-reuther.com](http://www.bopp-reuther.com)

Z-ML-KE ORZ-OI-OAP-OK-OP-elektrisch-V15 2023-01-30



<b>Richtlinie</b> <i>Directive</i> Directive	2014/68/EU /UE Druckgeräte <i>Pressure equipment</i> Équipements sous pression	L 189/164
<b>Konformitätsbewertungsverfahren</b> <i>Conformity assessment procedure</i> Procédures d'évaluation de la conformité	Modul B + Modul C2	
<b>Notifizierte Stelle</b> <i>Notified Body</i> <i>Organisme Notifié</i>	0036 TÜV SÜD Industrie Service GmbH Dudenstraße 28, D-68167 Mannheim	
<b>Normen und normative Dokumente</b> <i>Standards and normative documents</i> Normes et documents normatifs	AD 2000 Regelwerk <i>AD 2000 Code</i> Code AD 2000	
<b>Klassifizierung</b> <i>Classification</i> Classification	Rohrleitungsteil <i>Pipe</i> Tuyauterie	
<b>Fluid Kategorie ; Diagramm</b> <i>Fluid category ; Diagramm</i> Dangerosité du fluide ; Tableau	Gruppe 1 ; Anhang II / 6 <i>Group 1 ; Attachment II / 6</i> Groupe 1 ; Appendice II / 6	
<b>Einstufung Druckgerät</b> <i>Classification équipement sous pression</i> Classification pressure equipment	Kategorie III <i>Category III</i> Catégorie III	

**Die Angaben zur Richtlinie 2014/68/EU ist nur gültig für Druckgeräte die unter Artikel 4 Absatz 1 und 2 fallen, alle anderen unterliegen der guten Ingenieurspraxis nach Artikel 4 Absatz 3.**

*The information on Directive 2014/68 / EU is only valid for pressure equipment that falls under Article 4 Paragraph 1 and 2, all others are subject to good engineering practice according to Article 4 Paragraph 3.*

Les informations sur la directive 2014/68 / UE ne sont valables que pour les équipements sous pression relevant de l'article 4, paragraphes 1 et 2, tous les autres sont soumis aux bonnes pratiques d'ingénierie conformément à l'article 4, paragraphe 3.

<b>Richtlinie</b> <i>Directive</i> Directive	2011/65/EU /UE Beschränkung gefährlicher Stoffe <i>Restriction of hazardous substances</i> Limitation de substances dangereuses	L 174/88
<b>Delegierte Richtlinie</b> <i>Delegated Directive</i> Directive Déléguée	(EU /UE) 2015/863 Änderung Anhang II der Richtlinie 2011/65/EU <i>Amending Annex II to Directive 2011/65/EU</i> Modifiant l'annexe II de la directive 2011/65/UE	L 137/10
<b>Normen und normative Dokumente</b> <i>Standards and normative documents</i> Normes et documents normatifs	EN IEC 63000:2018	

**Ort, Datum / Place, Date / Lieu, Date:**

**Speyer, 2023-01-30**

  
**Dr. J. Ph. Herzog**  
**Geschäftsführer**  
*Managing director / Gérant*

**i. V. J. Riedl**  
**stv. QM Beauftragter**  
*Deputy QM Officer / Adjoint chargé de la qualité*

Bopp & Reuther Messtechnik GmbH, Am Neuen Rheinhafen 4, 67346 Speyer / Germany  
**Telefon:** +49(0)6232 657-0, **Telefax:** +49(0)6232 657-505, **Email:** [info@bopp-reuther.com](mailto:info@bopp-reuther.com), **Internet:** [www.bopp-reuther.com](http://www.bopp-reuther.com)

Z-ML-KE ORZ-OI-OAP-OK-OP-elektrisch-V15 2023-01-30

**Notes:**

## Our product portfolio:

### Volume flowmeter:

- Oval wheel meter
- Turbine meter
- Electromagnetic flowmeter

### Mass flowmeter:

- Vortex meter
- Compact orifice
- Coriolis mass flowmeter

### Density and concentration meter (Measuring and testing equipment)

### Dosing measurement technology

- Electromagnetic flowmeter
- Coriolis mass flowmeter
- Oval wheel meter
- Dosing control system

### Measurement Accessories

- Processing electronics
- Mechanical indicator
- Pulse pick-ups
- Components

### Measuring and testing equipment

### Conformity assessment according to MID Directive 2014/32/EU

### After Sales Service

Bopp & Reuther Messtechnik GmbH  
Am Neuen Rheinhafen 4  
67346 Speyer  
Germany  
Phone: +49 6232 657-0  
Fax: +49 6232 657- 505  
Email: [info@bopp-reuther.com](mailto:info@bopp-reuther.com)  
<https://www.bopp-reuther.com>

**BOPP & REUTHER**  
**MESSTECHNIK**

